



ROMI C 1100H | ROMI C 1290H | ROMI C 1300H | ROMI C 1300HBB
ROMI C 1600H | ROMI C 1800H | ROMI C 2100H | ROMI C 2200H | ROMI C 2600H

HEAVY DUTY CNC LATHES

ROMI C SERIES



ROMI Industrial Complex, in
Santa Bárbara d'Oeste - SP, Brazil

INNOVATION + QUALITY

ROMI: Producing high quality technology since 1930.

Since the beginning, Romi has been recognized for its focus on creating products and innovative solutions which has guaranteed its technological leadership among large manufacturers of machine tools. Romi's industrial complex is among the most modern and productive sites in the fields of machine tools, plastic processing machines, and high quality cast iron parts.

Continuous investments in Research & Development result in products with state-of-the-art technology.

The technology applied to Romi machines offers highly reliable products, with high accuracy, efficiency and great flexibility for several types of machining processes. Romi R&D is focused on increasing competitiveness for its customers.

Present throughout Brazil and in over 60 countries.

Romi covers all domestic territory through its sale subsidiaries network fully prepared to support customers by supplying an extensive range of services from marketing to after sales assistance. The international market is covered by Romi's subsidiaries which are located in the United States, Mexico, Europe, and by its many dealers located in strategic logistic centers around the globe that are capable of serving customers in 5 continents.



ROMI C SERIES



| ROMI C 1100H | ROMI C 1290H | ROMI C 1300H | ROMI C 1300HBB | ROMI C 1600H | ROMI C 1800H | ROMI C 2100H | ROMI C 2200H | ROMI C 2600H

Flexibility for several levels of application with assured productivity.

CNC lathes from ROMI C Series are machines with great flexibility for machining several types of parts, with great level of power, quick movements and machining accuracy.

They are targeted on oil & gas, sugar mill, naval, steel mills and energy segments of heavy industries. Robust structure with monoblock cast iron bed and outlets for chips and coolant fluid.

Robust machines for machining heavy duty parts with high efficiency and productivity.



- Headstock ASA A2-20"
- Spindle thru-hole: \varnothing 375 mm (14.8)
- Swing over bed: 1,110 mm (44") (ROMI C 1100H)
1,330 mm (52") (ROMI C 1290H)
- Main motor: 72 hp / 53 kW
- Tailstock with motorized displacement, manual driven quill with built-in live center and compensation by plate springs with monitoring system by load sensors of the thrust force and manual lubrication
- CNC Siemens 840D with high performance and reliability

ROMI C 1100H / C 1290H

Capacities

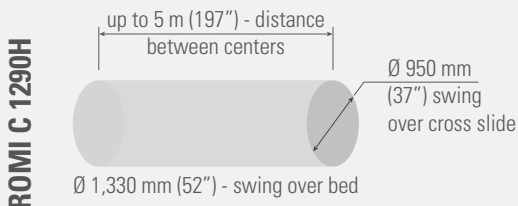
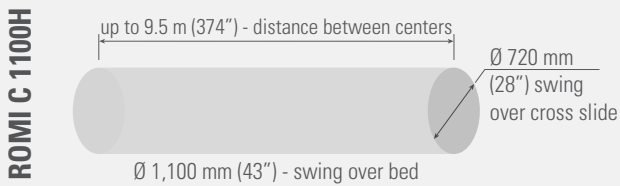

Power Graphs

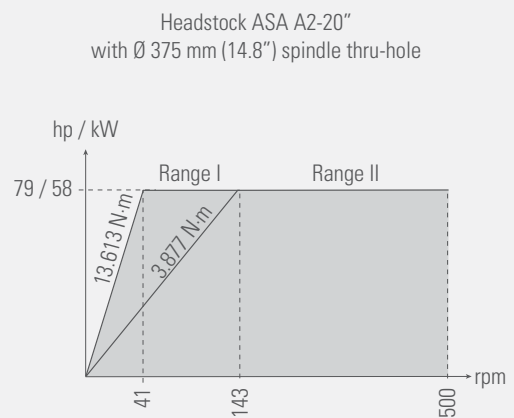

Drawings are not in scale.



Technology, reliability and productivity for manufacturing and repair of heavy duty parts.



- Headstock ASA A2-20", Ø 305 mm (12") thru-hole
- Headstock Flat Nose, Ø 575 mm (23") thru-hole (ROMI C 1300HBB - Big Bore)
- Swing over bed: 1,300 mm (51") (ROMI C 1300H / C 1300HBB)
1,600 mm (63") (ROMI C 1600H)
- Main motor (30 min. rating): 114 hp / 84 kW
- Tailstock with motorized displacement, manual driven quill with built-in live center and compensation by plate springs with monitoring system by load sensors of the thrust force
- CNC Siemens 840D with high performance and reliability

ROMI C 1300H / C 1600H / C 1300HBB

Capacities

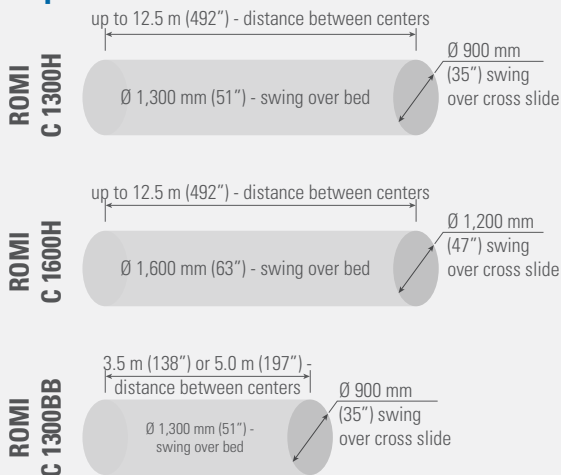

Power Graphs

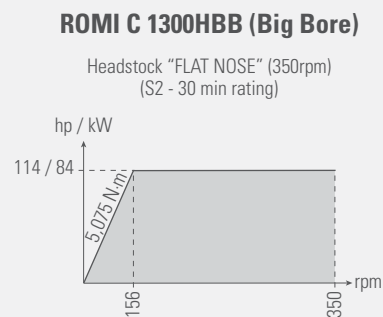
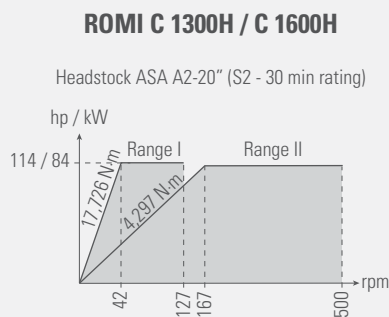

Drawings are not in scale.

Machines of extremely robust structures for machining heavy duty parts with high efficiency and productivity.



- Headstock ASA A2-20", Ø 305 mm (12") thru-hole
- Swing over bed: 1,800 mm (71") (ROMI C 1800H)
2,150 mm (85") (ROMI C 2100H)
- Main motor (30 min. rating): 114 hp / 84 kW
- Tailstock with motorized displacement, manual driven quill with built-in live center and compensation by plate springs with monitoring system by load sensors of the thrust force
- CNC Siemens 840D with high performance and reliability

ROMI C 1800H / C 2100H

Capacities

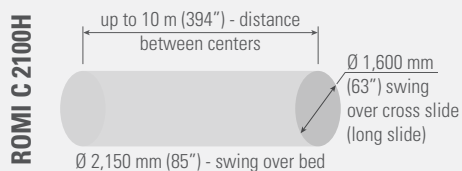
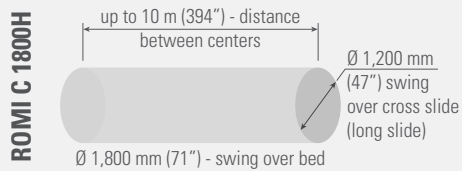

Power Graphs

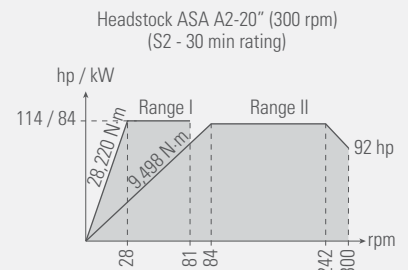
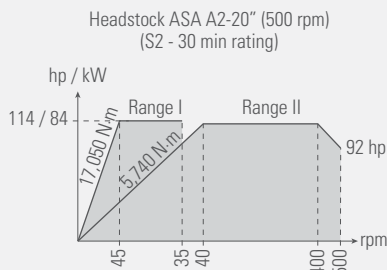

Drawings are not in scale.



The quality of the project and manufacturing processes assure the reliability and operational effectiveness.



- Headstock ASA A2-20", Ø 305 mm (12") thru-hole
- Swing over bed: 2,100 mm (83") (ROMI C 2200H)
2,580 mm (102") (ROMI C 2600H)
- Main motor (30 min. rating): 155 hp / 114 kW
- Tailstock with motorized displacement, manual driven quill with built-in live center and compensation by plate springs with monitoring system by load sensors of the thrust force
- CNC Siemens 840D with high performance and reliability

ROMI C 2200H / C 2600H

Capacities

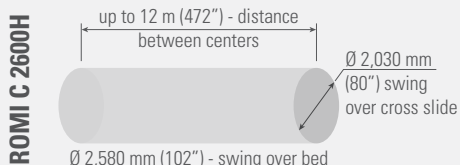
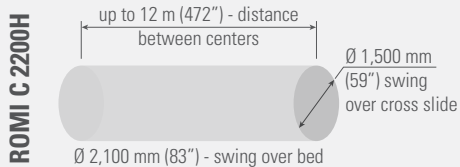

Power Graphs

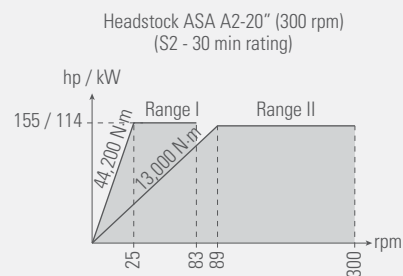
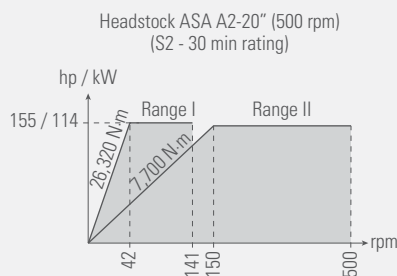

Drawings are not in scale.

ROMI C 1100H
bed.

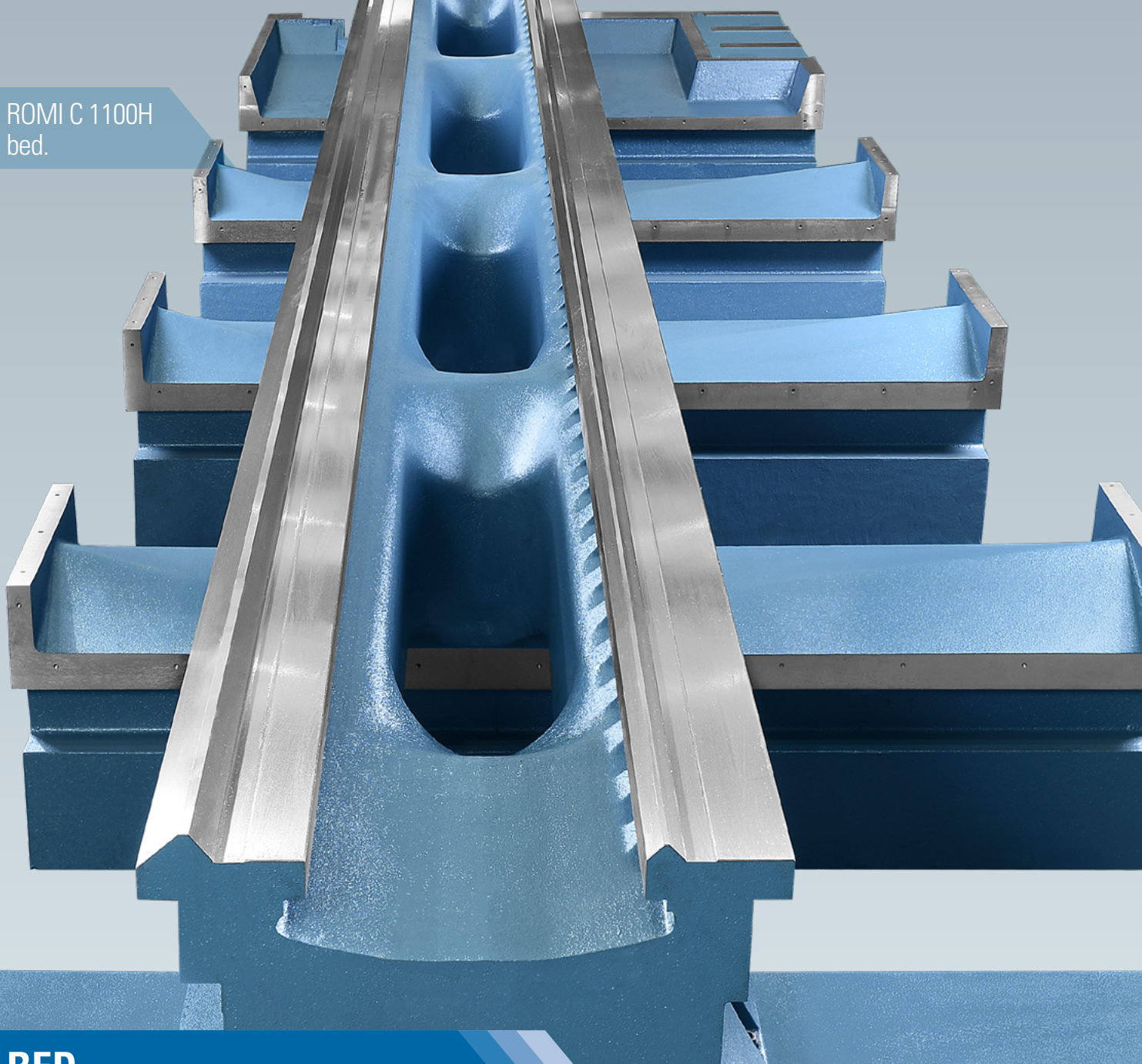

BED

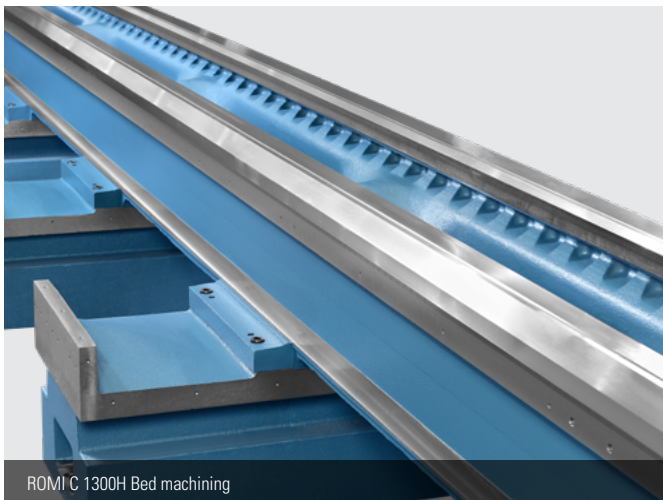

ROMI C 1300H Bed machining

Robust monoblock bed made of gray cast iron. Offers great rigidity, absorbing high machining efforts and vibration, assuring stability and accuracy at full power operation. The bed is a base for components supporting and it is fixed on the foundation by levelling and alignment elements.

Guides

They constitute a self-adjusting system, assuring permanent contact of cross slide over the bed.

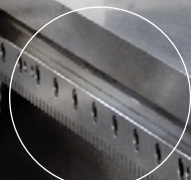
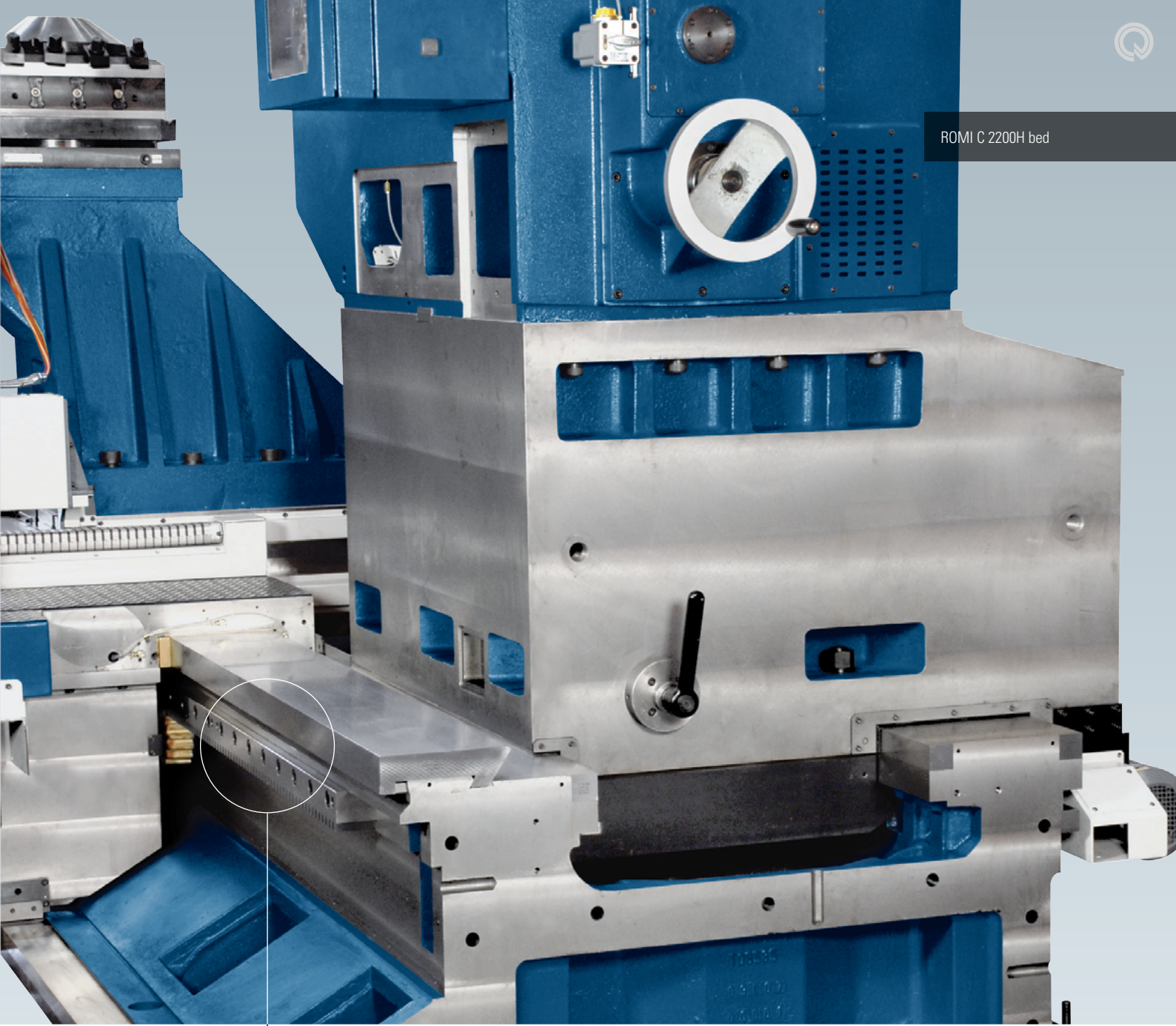

Rack (Güdel) of the longitudinal saddle displacement system.



Rack of the tailstock displacement system.

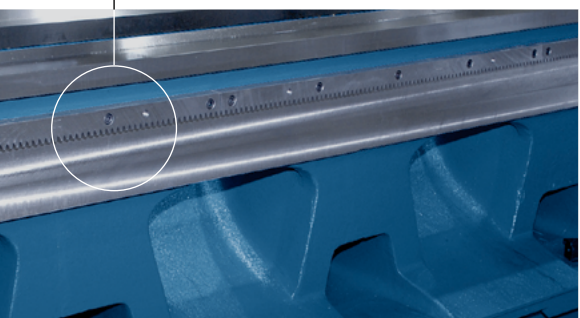

ROMI C 2200H Bed machining

Cast iron robust housing, internally ribbed to absorb high efforts of heavy machining operations.

Headstock ASA A2-20"
ROMI C 1100H / C 1290H

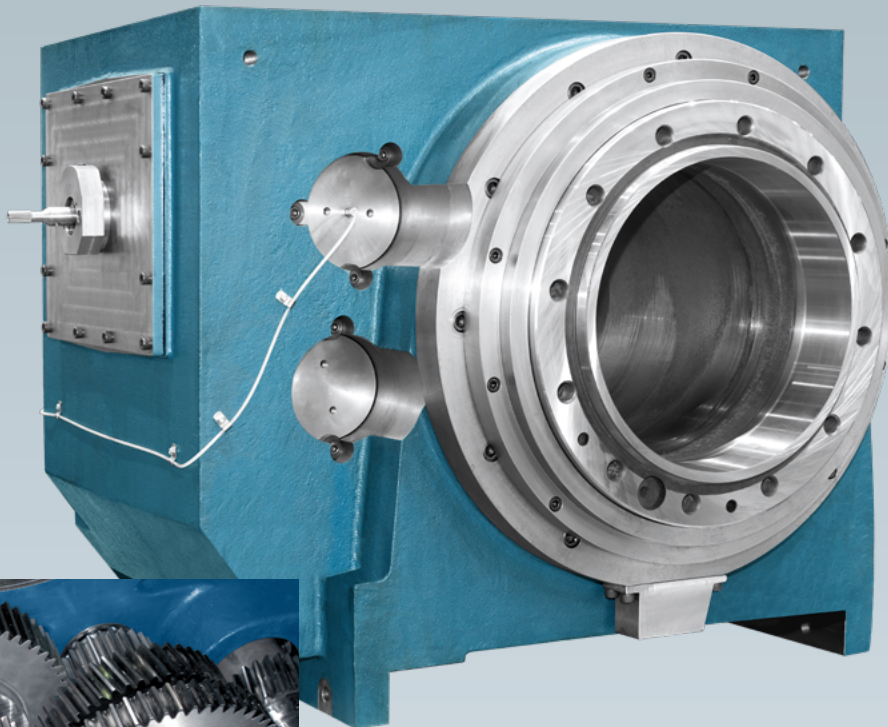

Gears from the headstock transmission system with hardened and ground teeth, designed to withstand the high efforts of the most severe working conditions.

HEADSTOCK

Cast iron robust housing, internally ribbed to absorb high efforts of heavy machining operations.

Spindle is held by Timken precision bearings. The high loading capacity of bearings provides rigidity and high vibration absorption under the most severe cutting conditions, obtaining parts with excellent geometric accuracy.

It is powered by AC motor by pulleys and poly-V belt, with high torque and continuously variable speeds.

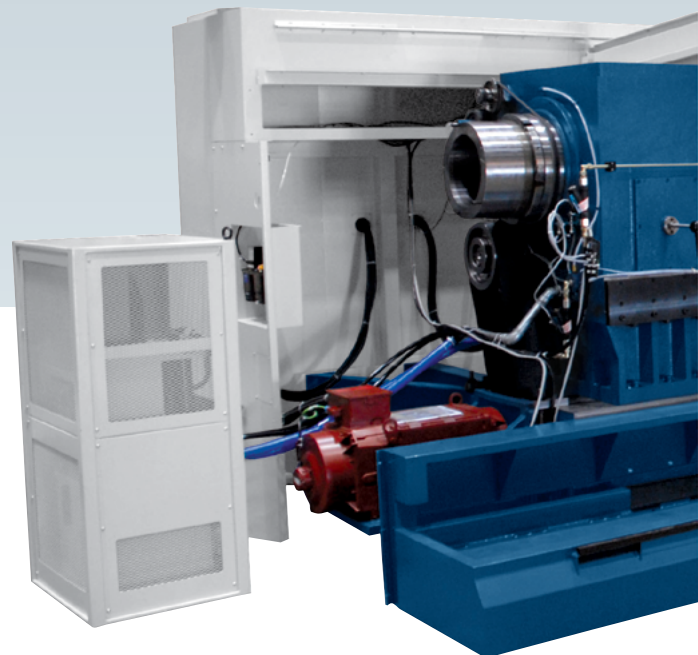

Headstock lubrication system

Ensures that all components of the headstock are constantly lubricated with an ideal working temperature. The system has an air / oil heat exchanger with thermostat to ensure temperatures lower than 40 degrees. It has dosage system and digital flow sensors, beyond of magnetic elements and suction filter, in order to protect bearings and pump gears against the contamination with particles.

Offers high load capacity,
rigidity and vibration absorption.

ROMI C 1100H / C 1290H
Tailstock

TAILSTOCK

The manually driven quill has a built-in live center with high precision bearings. It has a monitoring system by load sensors of the thrust force. Its displacement is driven by gearmotor and pinion/rack system.

Tailstock - ROMI
C 2200H / C 2600H,
with platform for
operator.

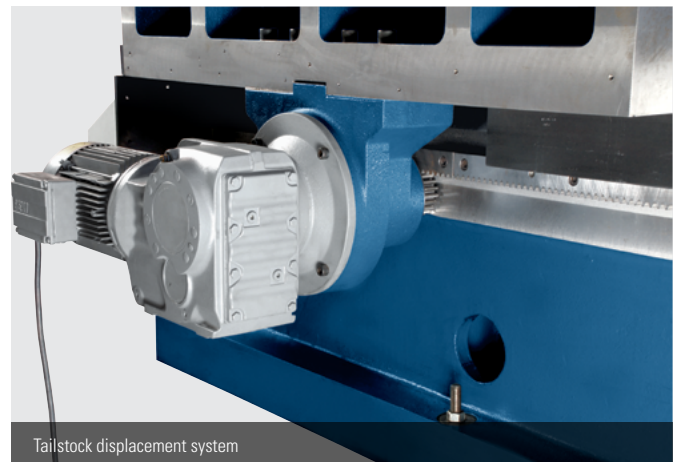

Tailstock displacement system

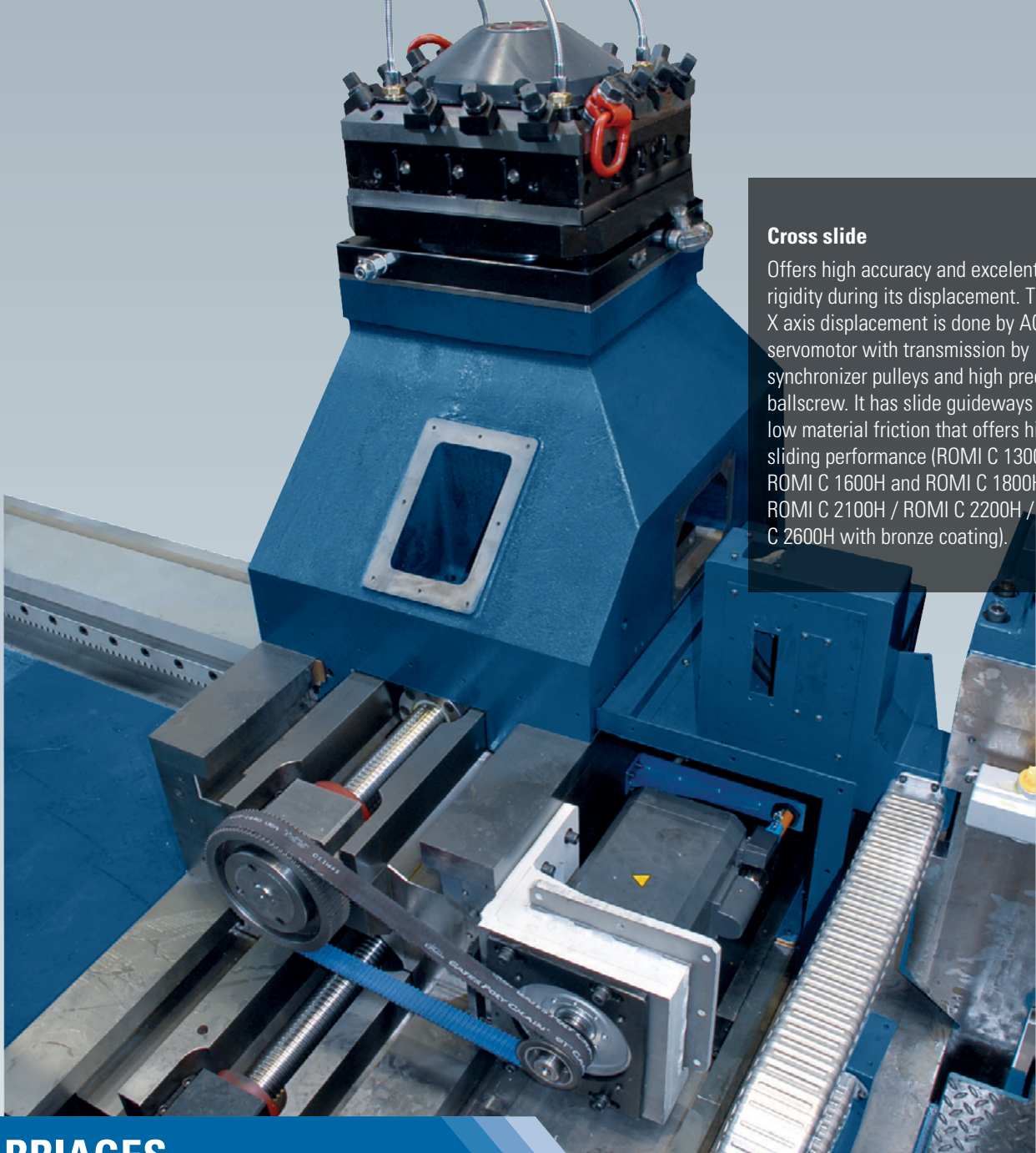

Cross slide

Offers high accuracy and excellent rigidity during its displacement. The X axis displacement is done by AC servomotor with transmission by synchronizer pulleys and high precision ballscrew. It has slide guideways with low material friction that offers high sliding performance (ROMI C 1300H / ROMI C 1600H and ROMI C 1800H / ROMI C 2100H / ROMI C 2200H / ROMI C 2600H with bronze coating).

CARRIAGES

Longitudinal saddle

Driven by servo motor through a pre-loaded double pinion system (Redex) that operates on the bed precision racks (Güdel), with positioning reading through linear scale (Heidenhain) (ROMI C 1800H / ROMI C 2100H / ROMI C 2200H / ROMI C 2600H / and ROMI C 1300H / ROMI C 1600H from 6.5 to 12.5 m (256" to 492") between centers).
 Driven by servo motor through precision recirculating ball screw (ROMI C 1300H / ROMI C 1600H with 3.5 m (138") and 5 m (197") between centers). It has guideways with low friction coefficient material that offers high sliding performance (ROMI C 1100H / C 1290H / C 1300H / C 1600H / C 1300HBB; and ROMI C 1800H / C 2100H / C 2200H / C 2600H with bronze coating).

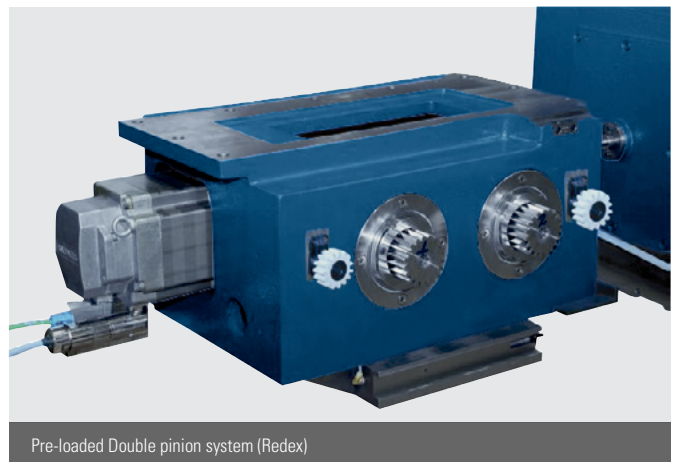

Pre-loaded Double pinion system (Redex)



Steady rest U type (optional)
It has 5 cartridges with rollers for diameter adjustment.
The steady rest body displacement is done by the longitudinal saddle.

RESTS

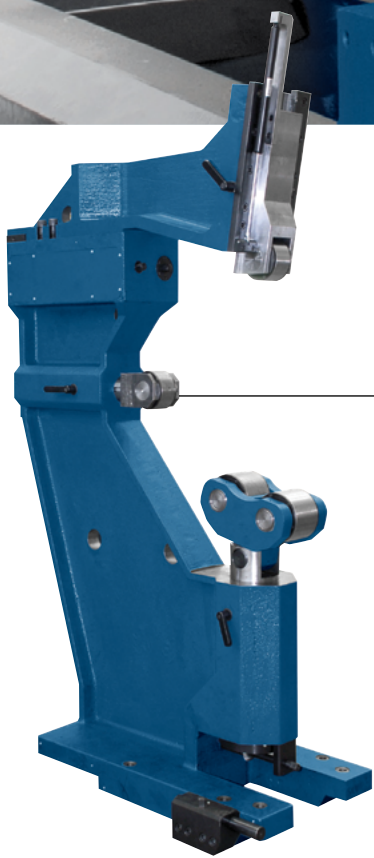

Steady rest C type (optional)
Table rest (optional)
Equipped with rollers and manual diameter adjustment.
It has a drag system via longitudinal saddle for its positioning.

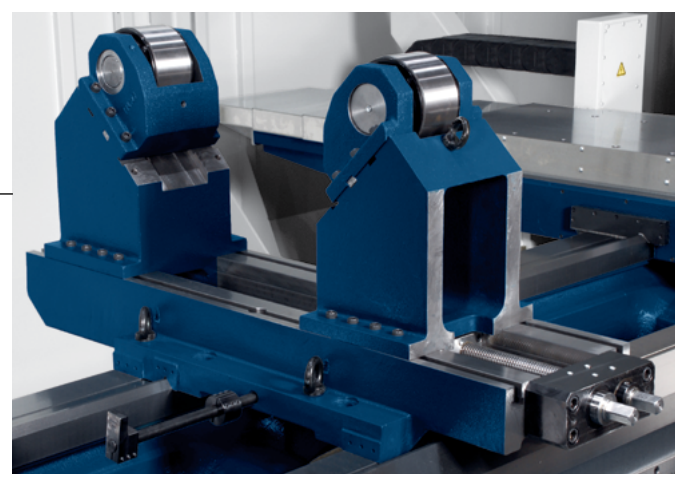

Electrical turret for driven tools with Y axis (optional)

12 station tool disk VDI-60 for driven tools, 10 hp (7.5 kW) 2,500 rpm (max.).



TURRETS



Turrets (optionals)

The heavy duty CNC lathes ROMI C Series are equipped with different robust turrets for several types of applications.

4 - station square vertical turret, electrically driven

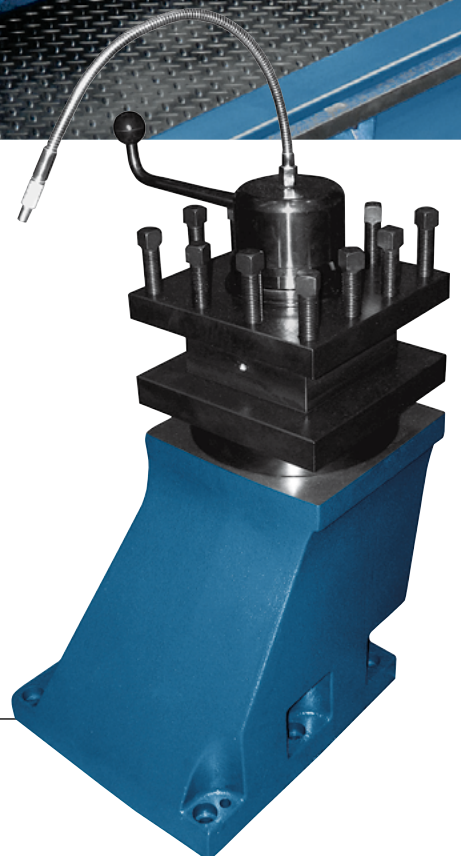

4 - station square manual turret

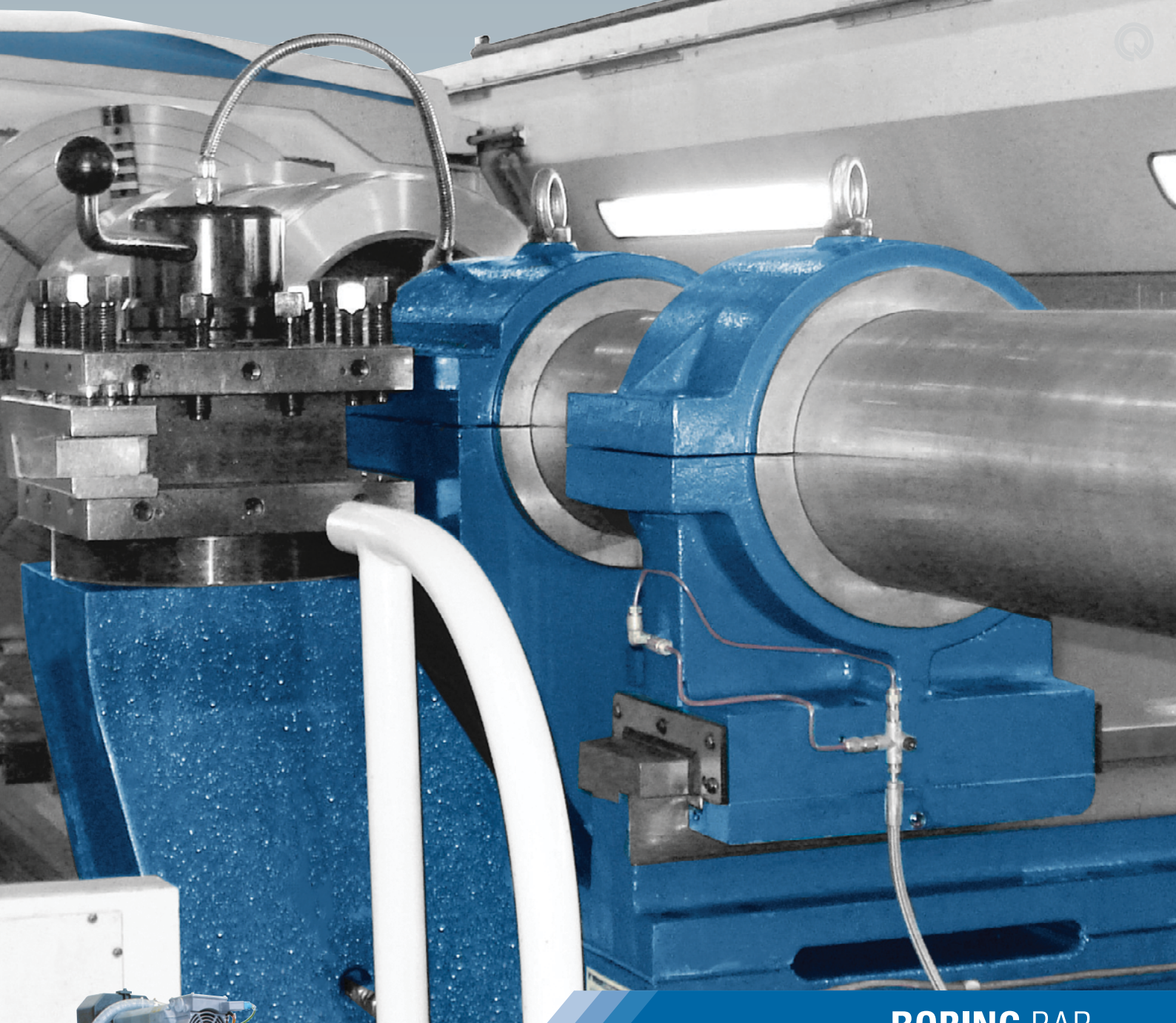

BORING BAR



Milling Headstock with Y axis (optional)
Spindle taper ISO-50, 16 hp / 12 kW, 2,500 rpm (max.)



Milling Headstock (optional)
Spindle taper ISO-50, 10 hp / 7.5 kW, 2,500 rpm (max.)

Boring bar holder

System with double support for the bar. Its robust structure offers high rigidity and vibration absorption during machining operations at full power.

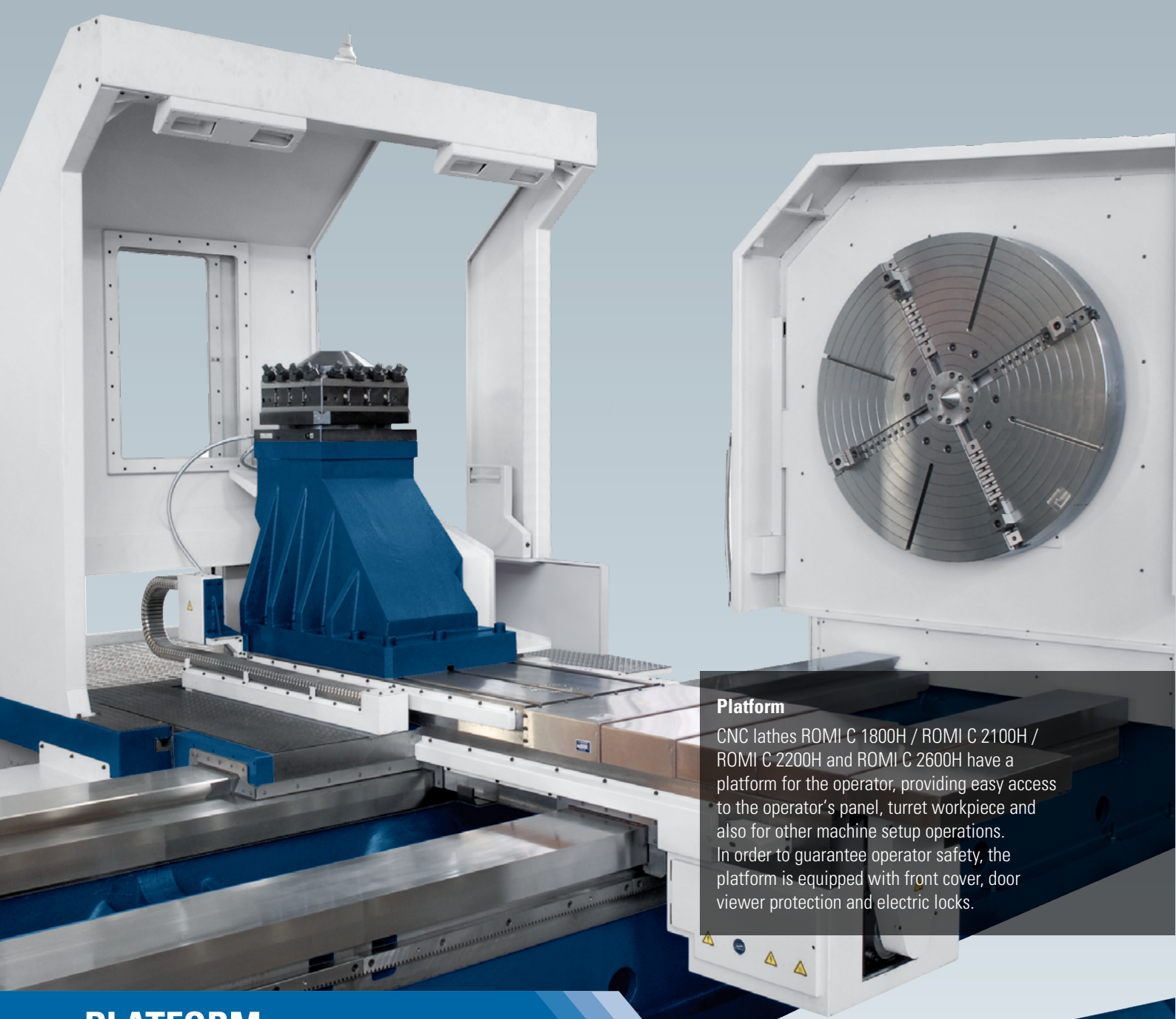

Platform

CNC lathes ROMI C 1800H / ROMI C 2100H / ROMI C 2200H and ROMI C 2600H have a platform for the operator, providing easy access to the operator's panel, turret workpiece and also for other machine setup operations. In order to guarantee operator safety, the platform is equipped with front cover, door viewer protection and electric locks.

PLATFORM

C axis (optional)

Mechanical system with independent servomotor, which is coupled to the machine spindle. Allows positioning the spindle at any angle, as well as perform interpolation operations in machining processes.





CNC

Technology, high performance and reliability

CNC horizontal lathes from ROMI C Series are equipped with CNC Siemens Sinumerik 840D which, offers the user very ease programming system.

CNC Siemens Sinumerik 840D offers 21.5" touch screen monitor, USB port and Ethernet interface for factory network, bringing a great flexibility for loading programs and parameters.

Conversational programming offered is the programGUIDE

CNC Siemens Sinumerik 840D programGUIDE facilitates program creation thru the input of data in user-friendly screens and animated elements which helps in unequivocal data input. Programming is simplified thru cycles of drilling, boring, tapping and milling cycles and free-shape profile cuts.

Technical specifications		ROMI C 1100H	ROMI C 1290H	ROMI C 1300H	ROMI C 1600H	ROMI C 1300HBB	ROMI C 1800H	ROMI C 2100H	ROMI C 2200H	ROMI C 2600H
Capacity										
Centers height	mm (in)	560 (22)	675 (27)	670 (26)	820 (32)	670 (26)	900 (35)	1,100 (43)	1,060 (42)	1,310 (52)
Distance between centers	m (in)	2.0 (79) / 3.5 (138) / 5.0 (197) / 6.5 (256) / 8.0 (315) / 9.5 (374)	3.5 (138) / 5.0 (197)	3.5 (138) / 5 (197) / 6.5 (256) / 8 (315) / 9.5 (374) / 11 (433) / 12.5 (492)		3.5 (138) / 5 (197)	4 (157) / 5.5 (217) / 7 (276) / 8.5 (335) / 10 (394)		4 (157) / 6 (236) / 8 (315) / 10 (394) / 12 (472)	
Swing over bed	mm (in)	1,110 (44)	1,330 (52)	1,300 (51)	1,600 (63)	1,300 (51)	1,800 (71)	2,150 (85)	2,100 (83)	2,580 (102)
Swing over saddle wings		1,055 (42)	1,280 (50)	900 (35)	1,200 (47)	900 (35)	1,200 (47)	1,600 (63)	1,500 (59)	2,030 (80)
Swing in front of cross slide (short carriage)	mm (in)	-		-		-	1,600 (63)	1,800 (71)	1,600 (63)	2,030 (80)
Swing over cross slide	mm (in)	720 (28)	950 (37)	900 (35)	1,200 (47)	900 (35)	1,200 (47)	1,600 (63)	1,500 (59)	2,030 (80)
Cross travel (X axis)	mm (in)	600 (24)		820 (32)		820 (32)	940 (37)	940 (37)	1,120 (44)	1,120 (44)
Cross travel - short (X axis)	mm (in)	-		-		-	-		500 (20)	500 (20)
Longitudinal travel (Z axis)	mm (in)	2,140 (84) / 3,665 (144) / 5,190 (204) / 6,715 (264) / 8,240 (324) / 9,765 (384) /	3,665 (144) / 5,190 (204)	3,605 (142) / 5,105 (201) / 6,605 (260) / 8,105 (319) / 9,605 (378) / 11,105 (437) / 12,605 (496)		3,605 (142) / 5,105 (201)	4,210 (166) / 5,710 (225) / 7,210 (284) / 8,710 (343) / 10,210 (402)		4,110 (162) / 6,110 (241) / 8,110 (319) / 10,110 (398) / 12,110 (477)	
Max. weight between centers at 50 rpm - ASA A2-15" (*)	kg (lbs)	-		15,000 (33,100)		22,000 (48,500)	-		-	
Max. weight between centers at 50 rpm - ASA A2-20" (*)	kg (lbs)	15,000 (33,100)		22,000 (48,500)		-	30,000 (66,100)		50,000 (110,200)	
Bed										
Width	mm (in)	600 (24)		800 (31)		800 (31)	1,400 (55)		1,840 (72)	
Height	mm (in)	490 (19)		720 (28)		720 (28)	760 (30)		800 (31)	
Headstock										
Spindle nose	ASA	A2-20"		A2-20"		Flat Nose	A2-20"	A2-20"	A2-20"	A2-20"
Spindle thru-hole diameter	mm (in)	375 (14.8)		305 (12)		575 (23)	305 (12)	305 (12)	305 (12)	305 (12)
Speed ranges (*)	rpm	1 to 500		1 to 500		1 to 350	1 to 500	1 to 300	1 to 500	1 to 300
Range I	rpm	1 to 143		1 to 125		-	1 to 168	1 to 100	1 to 150	1 to 89
Range II	rpm	1 to 500		1 to 500		-	1 to 500	1 to 300	1 to 500	1 to 300
Max. torque allowed	N.m	13,613		17,726		5,075	17,050	28,220	26,320	44,200
Front bearing inner diameter	mm (in)	431.8 (17)		431.8 (17)		660 (26)	431.8 (17)	431.8 (17)	431.8 (17)	431.8 (17)
Feeds										
Rapid traverse (Z axis)	m/min (in/min)	8 (315) (2.0 to 3.5 m between centers lathe)		10 (394) (6.5 to 12.5 m between centers lathe)		5 (197) (3.5 to 5 m between centers lathe)	8 (315)		8 (315)	
		5 (197) (5 m between centers lathe)		5 (197) (3.5 to 5 m between centers lathe)						
		10 (394) (6.5 to 9.5 m between centers lathe)								
Rapid traverse (X axis)	m/min (in/min)	8 (315)		8 (315)		8 (315)	8 (315)		8 (315)	
Tailstock										
Body positioning		Drag by saddle		Servo driven		Servo driven	Servo driven		Servo driven	
Quill drive		Manual (standard) Hydraulic (optional)		Manual (standard) Hydraulic (optional)		Manual (standard) Hydraulic (optional)	Manual (standard) Hydraulic (optional)		Manual (standard) Hydraulic (optional)	
Quill travel	mm (in)	300 (11.8)		300 (11.8)		300 (11.8)	300 (11.8)		450 (17.7)	
Quill diameter	mm (in)	200 (7.9)		290 (11.4)		290 (11.4)	290 (11.4)		330 (13)	
Live center (built-in)	metric	-		80 x 60°		80 x 60°	85 x 60°		100 x 60°	
Installed power										
Main motor AC S2 - 30 min. rating (continuous rating)	hp/kW	79 / 58		114 / 84 (82 / 60)		114 / 84 (82 / 60)	114 / 84 (82 / 60)		155 / 114 (96 / 70)	
Total power installed	kVA	60		95		95	100		150	
Dimensions and weight (approx.) (**)		2.0 m (79) between centers lathe		3.5 m (138) between centers lathe		3.5 m (138) between centers lathe	4.0 m (157) between centers lathe		6.0 m (236) between centers lathe	
Floor space (front x side)	m (in)	6.87 x 4.87 (270 x 192)		8.78 x 4.5 (346 x 177)		8.78 x 4.5 (346 x 177)	9.0 x 3.6 (354 x 142)		11.8 x 4.5 (465 x 177)	
Net weight (approx.)	kg (lbs)	18,000 (39,700)		28,420 (62,700) 29,200 (64,400)		28,420 (62,700) 29,200 (64,400)	44,000 (97,000) 45,000 (99,200)		60,000 (132,300) 61,000 (134,500)	

(*) Other characteristics like distance between centers, maximum admissible weight between centers, power and rotation can be offered under request

(**) Weight increase for each 1,500 mm (59") bed segment = 2,500 kg (5,500 lbs) (ROMI C 1100H / C 1290H)
Weight increase for each 1,500 mm (59") bed segment = 2,500 kg (5,500 lbs) (ROMI C 1300H / C 1600H)
Weight increase for each 1,500 mm (59") bed segment = 4,000 kg (8,800 lbs) (ROMI C 1800H / C 2100H)
Weight increase for each 2,000 mm (79") bed segment = 6,000 kg (13,200 lbs) (ROMI C 2200H / C 2600H)



Working layout

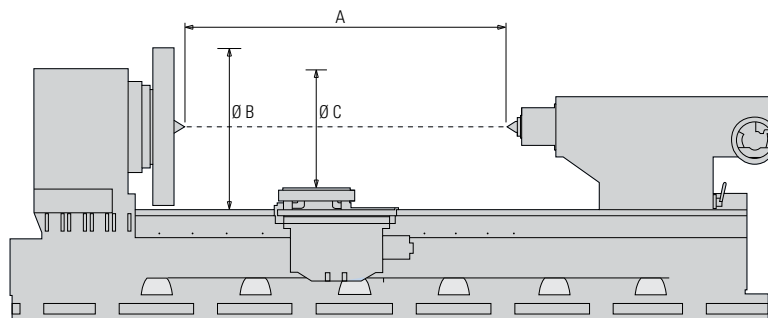

	A - m (in)	Ø B - mm (in)	Ø C - mm (in)
Romi C 1100H	2 (79) / 3.5 (138) / 5 (197) / 6.5 (256) / 8 (315) / 9.5 (374)	1,100 (43)	720 (28)
Romi C 1290H	3.5 (138) / 5 (197)	1,330 (52)	950 (37)
Romi C 1300H	3.5 (138) / 5 (197) / 6.5 (256) / 8 (315) / 9.5 (374) / 11 (433) / 12.5 (492)	1,300 (51)	900 (35)
Romi C 1600H	3.5 (138) / 5 (197) / 6.5 (256) / 8 (315) / 9.5 (374) / 11 (433) / 12.5 (492)	1,600 (63)	1,200 (47)
Romi C 1300HBB	3.5 (138) / 5 (197)	1,300 (51)	900 (35)
Romi C 1800H	4 (157) / 5.5 (217) / 7 (276) / 8.5 (335) / 10 (394)	1,800 (71)	1,200 (47) (long carriage) / 1,600 (63) (short carriage)
Romi C 2100H	4 (157) / 5.5 (217) / 7 (276) / 8.5 (335) / 10 (394)	2,150 (85)	1,600 (63) (long carriage) / 1,800 (71) (short carriage)
Romi C 2200H	4 (157) / 6 (236) / 8 (315) / 10 (394) / 12 (472)	2,100 (83)	1,500 (59) (long carriage) / 1,600 (63) (short carriage)
Romi C 2600H	4 (157) / 6 (236) / 8 (315) / 10 (394) / 12 (472)	2,580 (102)	2,030 (80) (long carriage) / 2,030 (80) (short carriage)

Drawings are not in scale.

Standard equipment

- Articulated and sliding operation panel (except ROMI C 1100H / C1290H)
- Centralized lubrication system with line filter oil and level sensor (PDI)
- Chip conveyor interface (except ROMI C 1100H / C 1290H)
- Coolant system with motor pump 10 l/min, 2 bar, 0.75hp / 0.56kW (ROMI C 1300H / C 1600H / C 1800H / C 2100H / C 2200H / C 2600H)
- Coolant system with two coolant pumps for choice 2 bar or 7 bar (ROMI C 1100H / 1290H)
- Electrical installation for 380 V or 400 V 50 / 60 Hz
- Electrical panel with air conditioning (except ROMI C 1100H / 1290H)
- Ethernet interface
- Fluorescent worklight
- Geared headstock, with two speed ranges and continuous speed variation
- Headstock coolant and lubrication system equipped with heat exchanger, sensors for temperature, pressure, flow and filter
- Remote operation panel with handwheel and JOG functions for axes
- Set of anchor, screws and nuts for leveling and alignment
- Set of instruction manuals
- Set of wrenches for machine operation
- CNC Siemens 840D, with 21.5" touch screen monitor
- Splash guard with sliding doors
- Standard colors: Textured epoxy enamel munsell blue 10B-3/4 and textured epoxy gray RAL 7035
- Tailstock with manually operated quill, built-in center with plate springs compensation and supervision of applied force and lubrication
- Pivoted operation panel (ROMI C 1100H / C 1290H)

Optional equipment

- 12-station horizontal electrical turret, VDI-50 for driven tools (tool holders and reduction sleeves not included) (ROMI C 1600H)
 - 3-jaw independent chuck, cast iron ASA A2-20" (flange not included):
 - Ø 630 mm, thru-hole Ø 252 mm (max. 500 rpm) ROMI C 1100H / 1290H
 - Ø 800 mm, thru-hole Ø 320 mm (max. 300 rpm) ROMI C 1100H / 1290H
 - Flange for 3-jaw universal chuck A2-20" Ø 630 ou Ø 800 mm
 - 4 jaw independent rear chuck steel body ASA A2-20":
 - Ø 720 mm, thru-hole Ø 375 mm (max. 873 rpm) ROMI C 1100H
 - 4-jaw independent chuck, steel body ASA A2-20":
 - Ø 700 mm (max. 873rpm) ROMI C 1100H / 1290H
 - Ø 720 mm, thru-hole Ø 375 mm (max. 873rpm) ROMI C 1100H / 1290H
 - Ø 800 mm (max. 764 rpm) ROMI C 1100H / 1290H / 1300H / 1600H / 1800H
 - Ø 900 mm (max. 679 rpm) ROMI C 1100H / 1290H
 - Ø 1000 mm (max. 611 rpm) ROMI C 1100H / 1290H / 1300H / 1600H / 1800H / 2100H / 2200H / 2600H
 - Ø 1100 mm (max. 509 rpm) ROMI C 1290H
 - Ø 1200 mm (max. 509 rpm) ROMI C 1300H / 1600H / 1800H / 2100H / 2200H / 2600H
 - Ø 1400 mm (max. 437 rpm) ROMI C 1800H / 2100H / 2200H / 2600H
 - Ø 1500 mm (max. 407 rpm) ROMI C 1300H / 1600H / 1800H / 2100H / 2200H / 2600H
 - Ø 1600 mm (max. 382 rpm) ROMI C 1800H / 2100H / 2200H / 2600H
 - Ø 1800 mm (max. 340 rpm) ROMI C 1800H / 2100H / 2200H / 2600H
 - Ø 2000 mm (max. 306 rpm) ROMI C 2200H / 2600H
 - 4-station square manual turret
 - 4-station vertical electrical turret (tool holders and reduction sleeves not included)
 - 8-station horizontal electrical turret for driven tools, VDI-50 (DIN 69880) (tool holders and reduction sleeves not included) (ROMI C 1100H / C 1290H)
 - 8-station horizontal electrical turret for driven tools, VDI-50 (DIN 69880) (tool holders and reduction sleeves not included)
 - 8-station horizontal electrical turret, VDI-50 (DIN 69880) (tool holders and reduction sleeves not included)
 - Air conditioning for electrical panel (recommended for environments with temperature higher than 38°C) (ROMI C 1100H / C 1290H)
 - Autotransformer for 200 to 250 VCA or 360 to 480 VCA, 50/60 Hz
 - Deep hole drilling support (bar not included):
 - Ø 160 mm (ROMI C 1100H / 1290H)
 - Ø 200 mm fixed over cross slide, with 3rd guide (ROMI C 1300H / 1600H)
 - Ø 200 mm fixed in square manual turret with vertical axis, with 3rd guide (ROMI C 1300H / C 1600H)
 - Ø 250 mm fixed over cross slide, with 3rd guide (ROMI C 1800H / 2100H / 2200H / 2600H)
 - Ø 250 mm fixed in square manual turret with vertical axis, with 3rd guide (ROMI C 1800H / 2100H / 2200H / 2600H)
 - C axis driven by independent servomotor and hydraulic brake
 - Chip conveyor hinged belt longitudinal (TCE)
 - Chip pan and coolant tank
 - Generic interface with miscellaneous functions (4 M codes)
 - Linear scale for Z axis
 - Main spindle indexing with 72 position (5 degrees) - ASA A2-20"
 - Oil Skimmer
 - Special painting according to Munsell or RAL Standards
 - Steady rest C type, with capacity:
 - Ø 300 to 800 mm (ROMI C 2600H)
 - Steady rest U type, with capacity:
 - Ø 230 to 550 mm (ROMI C 1100H)
 - Ø 200 to 635 mm (ROMI C 1290H)
 - Ø 230 to 600 mm (ROMI C 1300H / 1600H / 2100H)
 - Ø 380 to 750 mm (ROMI C 1600H)
 - Ø 275 to 800 mm (ROMI C 1800H / 2100H)
 - Ø 300 to 800 mm (ROMI C 2200H / 2600H)
 - Steady table rest, with capacity:
 - Ø 340 to 720 mm (ROMI C 1100H)
 - Ø 300 to 950 mm (ROMI C 1290H)
 - Ø 500 to 900 mm (ROMI C 1300H / C 1300HBB)
 - Ø 500 to 1,200 mm (ROMI C 1600H)
 - Ø 750 to 1,200 mm (ROMI C 1800H)
 - Ø 800 to 1,600 mm (ROMI C 2100H)
 - Ø 800 to 1,550 mm (ROMI C 2200H)
 - Ø 800 to 2,000 mm (ROMI C 2600H)
 - Table rest
 - Tailstock with hydraulically driven quill, built-in live center and displacement through carriage in place of standard
 - Y axis
 - Remote diagnosis interface
- Note: Other optional equipments under request.

WORLDWIDE PRESENCE

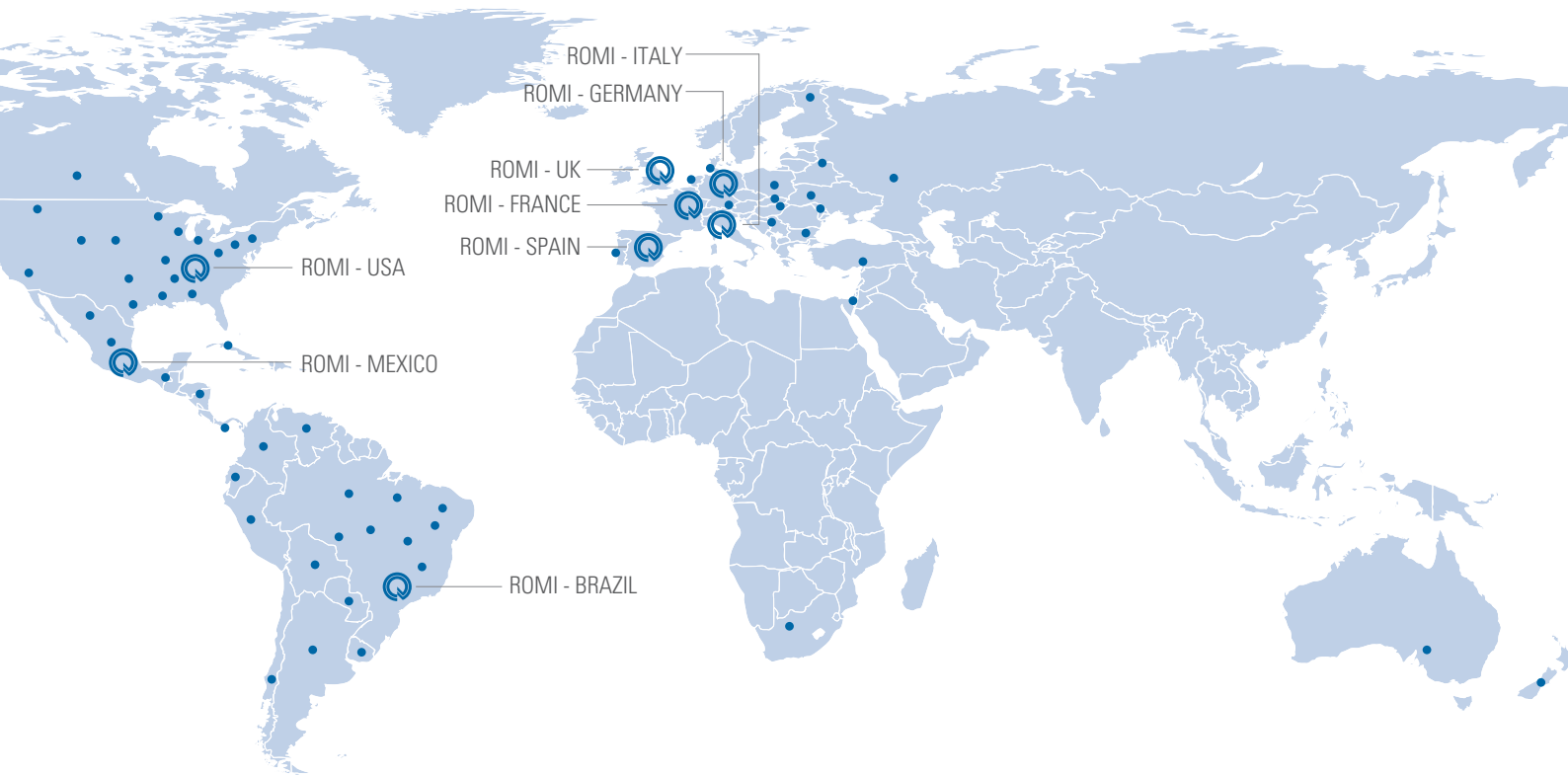

ROMI

WWW.ROMI.COM

ROMI S.A.
Rod. SP 304, Km 141,5
Santa Bárbara d'Oeste SP
13459 057 Brazil
+55 (19) 3455 9000

Latin America
+55 (19) 3455 9642
export-mf@romi.com

**Burkhardt+Weber
Fertigungssysteme GmbH**
Burkhardt+Weber-Strasse 57
72760 Reutlingen, Germany
+49 7121 315-0
info@burkhardt-weber.de
www.burkhardt-weber.de

ROMI BW Machine Tools Ltd
1845 Airport Exchange Blvd
Erlanger KY – 41018 USA
+1 (859) 647 7566
sales@romiusa.com
www.romiusa.com

ROMI Europa GmbH
Burkhardt+Weber-Strasse 57
72760 Reutlingen, Germany
+49 7121 315-604
sales@romi-europa.de
www.romi-europa.de

ROMI France SAS
Parc de Genève, 240
Rue Ferdinand Perrier 69800
ST Priest
+33 4 37 25 60 70
infos@romifrance.fr
www.romifrance.fr

ROMI Machines UK Limited
Leigh Road
Swift Valley Industrial Estate
Rugby CV21 1DS
+44 1788 544221
sales@romiuk.com
www.romiuk.com

ROMI Maquinas España
C/ Telemática, 9 - Poligono
Industrial La Ferreria - 08110
Montcada I Reixac - Barcelona
+34 93 719 4926
info@romi.es
www.romi.es

ROMI en México
Condominio Parque Arista, Calle
Gral. Mariano Arista 54, bodega 19
Col. Argantina Poniente, Miguel Hidalgo
C.O. 11230, CDMX, México
+521 55 9154 5851
ventasmx@romi.com
www.romimexico.com

ROMI Itália Srl
Via Morigi, 33 – 29020
Gossolengo (PC) – Italy
+39 0523 778 956
commericale@romitalia.it
www.romitalia.it

CE safety regulation compliance available only for the European Community or under request.
Check availability and technical characteristics of the products to your country.



ISO 9001:2015
Certificate No. 31120



ISO 14001:2015
Certificate No. 70671