



| ROMI VT 1400M | ROMI VT 2000M | ROMI VT 2500M | ROMI VT 3000M | ROMI VT 5000 | ROMI VT 6000

VERTICAL CNC LATHES

ROMI VT SERIES

ROMI Industrial Complex, in
Santa Bárbara d'Oeste - SP, Brazil



INNOVATION + QUALITY

ROMI: Producing high quality technology since 1930.

Since the beginning, Romi has been recognized for its focus on creating products and innovative solutions which has guaranteed its technological leadership among large manufacturers of machine tools. Romi's industrial complex is among the most modern and productive sites in the fields of machine tools, plastic processing machines, and high quality cast iron parts.

Continuous investments in Research & Development result in products with state-of-the-art technology.

The technology applied to Romi machines offers highly reliable products, with high accuracy, efficiency and great flexibility for several types of machining processes. Romi R&D is focused on increasing competitiveness for its customers.

Present throughout Brazil and in over 60 countries.

Romi covers all domestic territory through its sale subsidiaries network fully prepared to support customers by supplying an extensive range of services from marketing to after sales assistance. The international market is covered by Romi's subsidiaries which are located in the United States, Mexico, Europe, and by its many dealers located in strategic logistic centers around the globe that are capable of serving customers in 5 continents.



ROMI VT SERIES



ROMI VT 1400M



ROMI VT 2000M



ROMI VT 2500M



ROMI VT 3000M

ROMI VT 5000

ROMI VT 6000

Technology and productivity for machining of heavy workpieces.

The robust mechanical structure of ROMI VT Series provides rigidity, stability and versatility in machining processes of a wide range of workpieces found in the heavy industry, such as rings, sleeves, flanges and covers among others.

Flexibility and productivity for several applications with capacity to machine parts weighing up to 10 tons (22,000 lbs)

- Chuck diameter: \varnothing 1,400 mm (55")
- Max weight allowed on chuck: 10,000 kg (22,000 lbs)
- Maximum speed: 335 rpm
- Main motor: 84 hp / 62 kW
- Vertical RAM, with driven tool and C axis, with 20-tool magazine



ROMI VT 1400M

Capacity

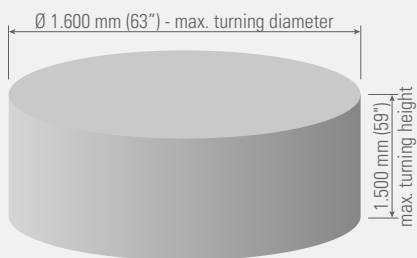

Power Graphs

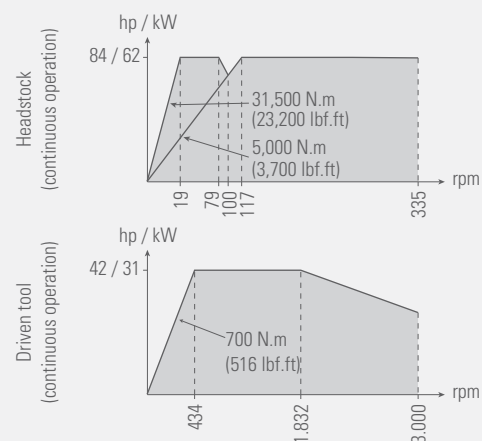



High performance, flexibility and productivity for several applications with capacity to machine parts weighing up to 15 tons (33,000 lbs).

- Chuck diameter: \varnothing 2,000 mm (79")
- Max weight allowed on chuck: 15,000 kg (30,000 lbs)
- Maximum speed: 250 rpm
- Main motor: 84 hp / 62 kW
- Vertical RAM, with driven tool and C axis, with 20-tool magazine



ROMI VT 2000M

Capacity

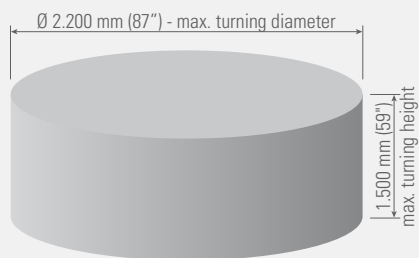

Power Graphs

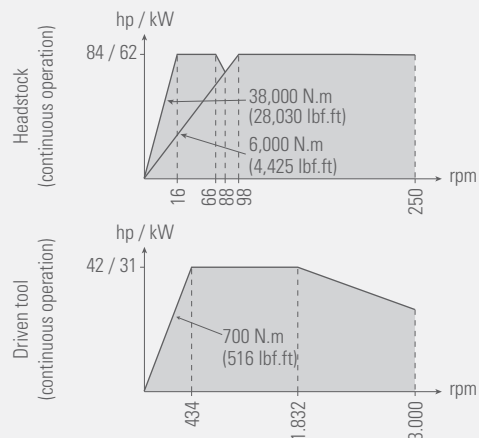

High performance, flexibility and productivity for several applications with capacity to machine parts weighing up to 25 tons (55,100 lbs).

ROMI VT 2500M

- Chuck diameter: Ø 2,500 mm (98")
- Max weight allowed on chuck: 25,000 kg (55,100 lbs)
- Maximum speed: 180 rpm
- Main motor: 84 hp / 62 kW
- Vertical RAM, with driven tool and C axis with 20-tool magazine

ROMI VT 3000M

- Chuck diameter: Ø 3,000 mm (118")
- Max weight allowed on chuck: 25,000 kg (55,100 lbs)
- Maximum speed: 150 rpm
- Main motor: 84 hp / 62 kW
- Vertical RAM, with driven tool and C axis with 20-tool magazine



ROMI VT 2500M / VT 3000M

Capacities

ROMI VT 2500M

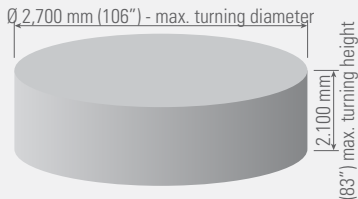

ROMI VT 3000M

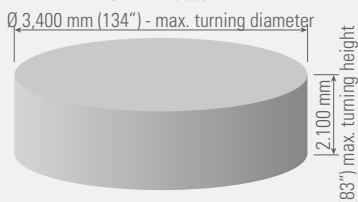

Power Graphs

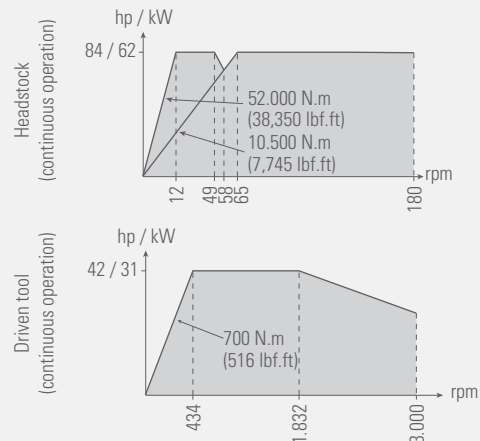



Extremely robust structure and high technology with capacity to machine parts weighing up to 90 tons (198,400 lbs).



ROMI VT 5000

- Chuck diameter: Ø 5,000 mm (197")
- Max weight allowed on chuck: 90,000 kg (198,400 lbs)
- Maximum speed: 50 rpm
- Main motor: 145 hp / 108 kW
- Vertical RAM, with driven tool and C axis with 10-tool magazine

ROMI VT 6000

- Chuck diameter: Ø 6,000 mm (236")
- Max weight allowed on chuck: 90,000 kg (198,400 lbs)
- Maximum speed: 50 rpm
- Main motor: 145 cv / 108 kW
- Vertical RAM, with driven tool and C axis with 10-tool magazine

ROMI VT 5000 / VT 6000

Capacities

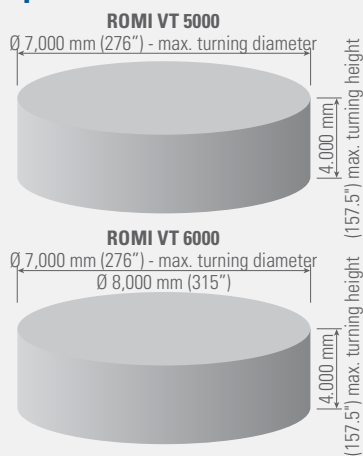

Power Graphs

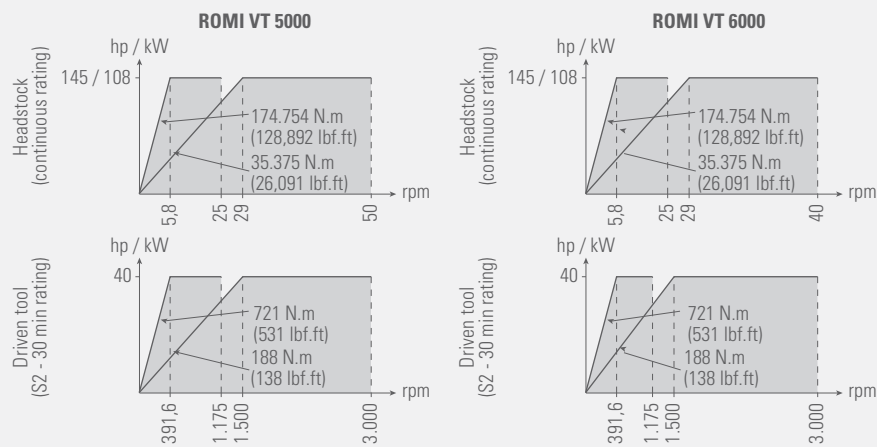

Robust structure with high accelerations, accuracy and stability.



**ROMI VT 1400M /
ROMI VT 2000M**
Structure

STRUCTURE

1 Column

The robust structure supports the cross rail and the vertical carriage, providing rigidity, vibration absorption and excellent geometric stability for heavy machining operations.

2 Vertical carriage

Cast iron structure which incorporates the assembly comprised of vertical carriage (Z axis) and cross rail (X axis)

3 Axes

Axes driven by AC servomotors and high accuracy ball screws.

4 Programmable Cross Rail (Axis W)

The cast iron structure supports the whole vertical carriage assembly, allowing vertical displacement in each 150 mm (5.9").

It offers high rigidity and stability for full power machining. Equipped with linear roller guideways with anti-vibration system.

5 Motor

Motors coupled to gearbox, providing high torque during low speeds.

6 Headstock

It has two motors 31 kW (31 + 31 = 62 kW), comprising DDS system (Dual Drive System) for chuck drive. This technology eliminates the vibrations caused by transmission elements resulting in high quality finishing surface with more precision and reliability.

7 Base

Robust and designed to support high loads and absorb vibrations.

8 Chuck

Equipped with 4-jaw, made of cast iron. Chuck is directly coupled to the headstock transmission system thru high precision gear.

9 Tool magazine

The magazine has capacity for 20 tools.

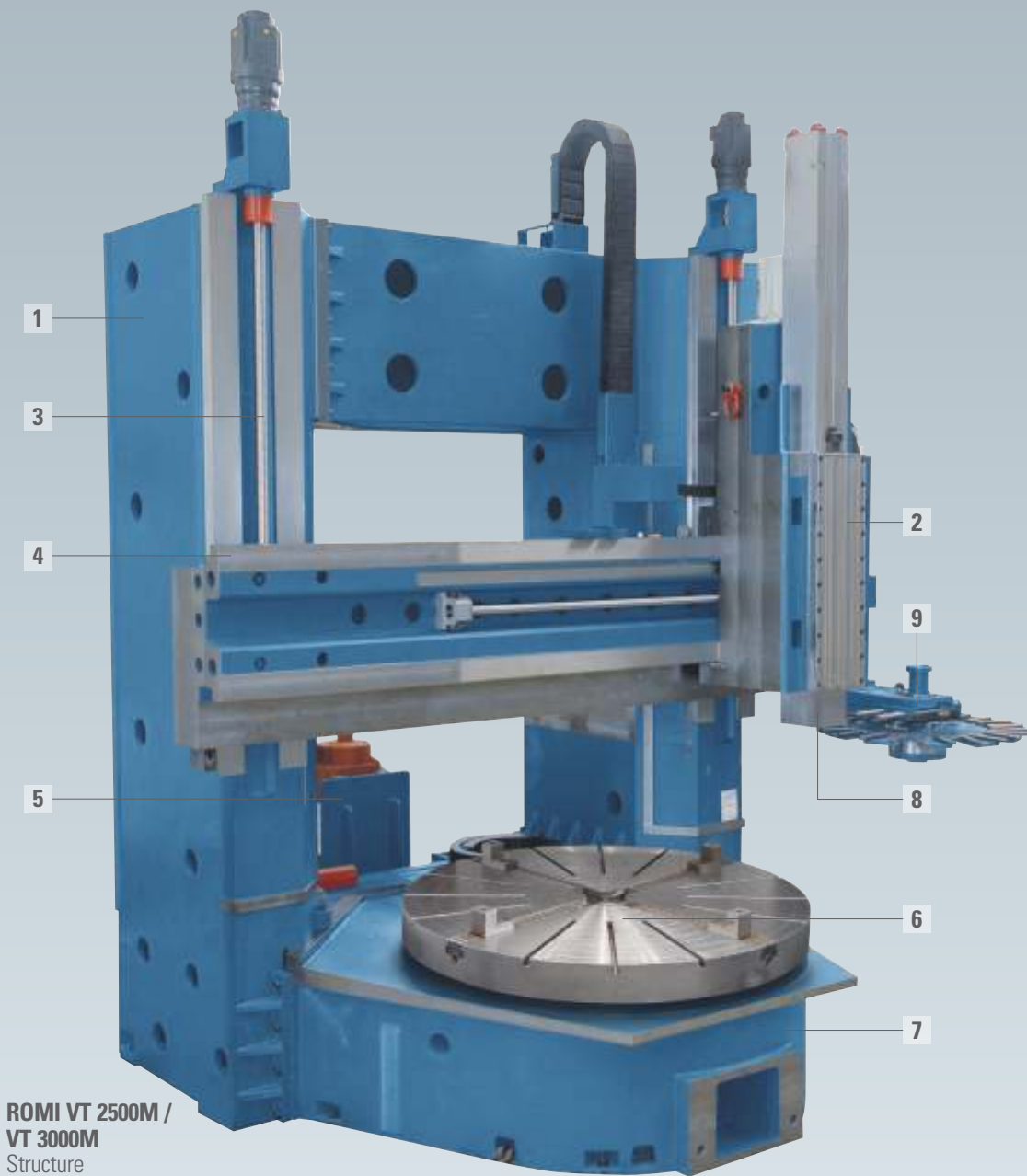

**ROMI VT 2500M /
VT 3000M**
Structure

1 Column

The robust structure supports the cross rail and the vertical carriage, providing rigidity, vibration absorption and excellent geometric stability for heavy machining operations.

2 Vertical carriage

Cast iron structure which incorporates the assembly comprised of vertical carriage (Z axis) and cross rail (X axis). Equipped with linear roller guideways providing rigidity and stability for heavy machining operations.

3 Axes

Axes driven by AC servomotors and high accuracy ball screws.

4 Programmable Cross Rail (Axis W)

The welded structure supports the whole vertical carriage assembly. It is supported in the assembly comprised of two casting

and machined columns interconnected by a traverse ensuring great rigidity for the system. The cross rail motion system is comprised of two servomotors and ball screw, with pre-programmed stops, granting safety and precision in the positioning of cross rail in the W axis.

5 Motor

Siemens motors provide high torque and power to the headstock. Motors coupled to gearbox, providing high torque during low speeds.

6 Headstock

It has two motors 31 kW (31 + 31 = 62 kW), comprising DDS system (Dual Drive System) for chuck drive. This technology eliminates the vibrations caused by transmission elements resulting in high quality finishing surface with more precision and reliability.

7 Base

Robust and designed to support high loads and absorb vibrations. The base encloses the headstock assembly, as well as the precision bearing way and the chuck transmission system.

8 Vertical RAM

It is made of forged, hardened and ground steel. It has hydraulic system for tool locking & unlocking and it can incorporate driven tool system, with interface for BT- 50 and tools with coupling Hirth, providing excellent stability and rigidity when machining.

9 Tool magazine

The magazine has capacity for 20 tools.



STRUCTURE

1 Base

Monoblock base made of cast iron offers high rigidity and great absorption of vibrations. It is base for installation of other components and is fixed in the foundation thru alignment and levelling elements.

2 Column

Robust structure responsible for holding the cross rail and vertical carriage offers rigidity absorption of vibrations and excellent geometric stability in heavy machining operations.

3 Headstock

Designed to absorb high impacts generated from heavy machining processes. It provides 2 speed ranges with continuous variation and it is equipped with cast iron main gear supported in hydrostatic system.

4 Programmable cross rail (W axis)

It is supported in the assembly comprised of two casting and machined columns interconnected by a traverse ensuring great rigidity for the system. The cross rail motion system is comprised of two servomotors and ball screw, with pre-programmed stops, granting safety and precision in the positioning of cross rail in the W axis.



Rack & pinion transmission system with helicoidal gears: accuracy and low noise level



BASE

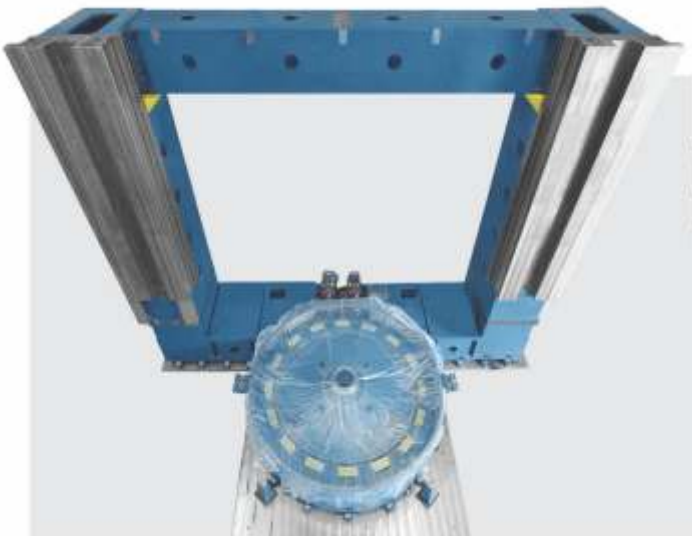

Robust, made of cast iron it supports the entire headstock, chuck and motor.

It has an efficient hydrostatic system for holding of chuck and parts besides a gear transmission system and motor.

ROMI VT 5000 and VT 6000 lathes are equipped with 8-jaw independent chuck made of cast iron. Chuck is directly coupled to the headstock transmission system thru high precision gear. The gear is designed according to DiN 3990, dimensioned to support efforts under severe machining conditions. Two speed ranges enable adequate torque for roughing operations and speed for finishing operations.



CHUCK

Headstock

It has two motors 54 kW ($54 + 54 = 108$ kW), comprising DDS system (Dual Drive System) for chuck drive. This technology eliminates the vibrations caused by transmission elements resulting in high quality finishing surface with more precision and reliability.



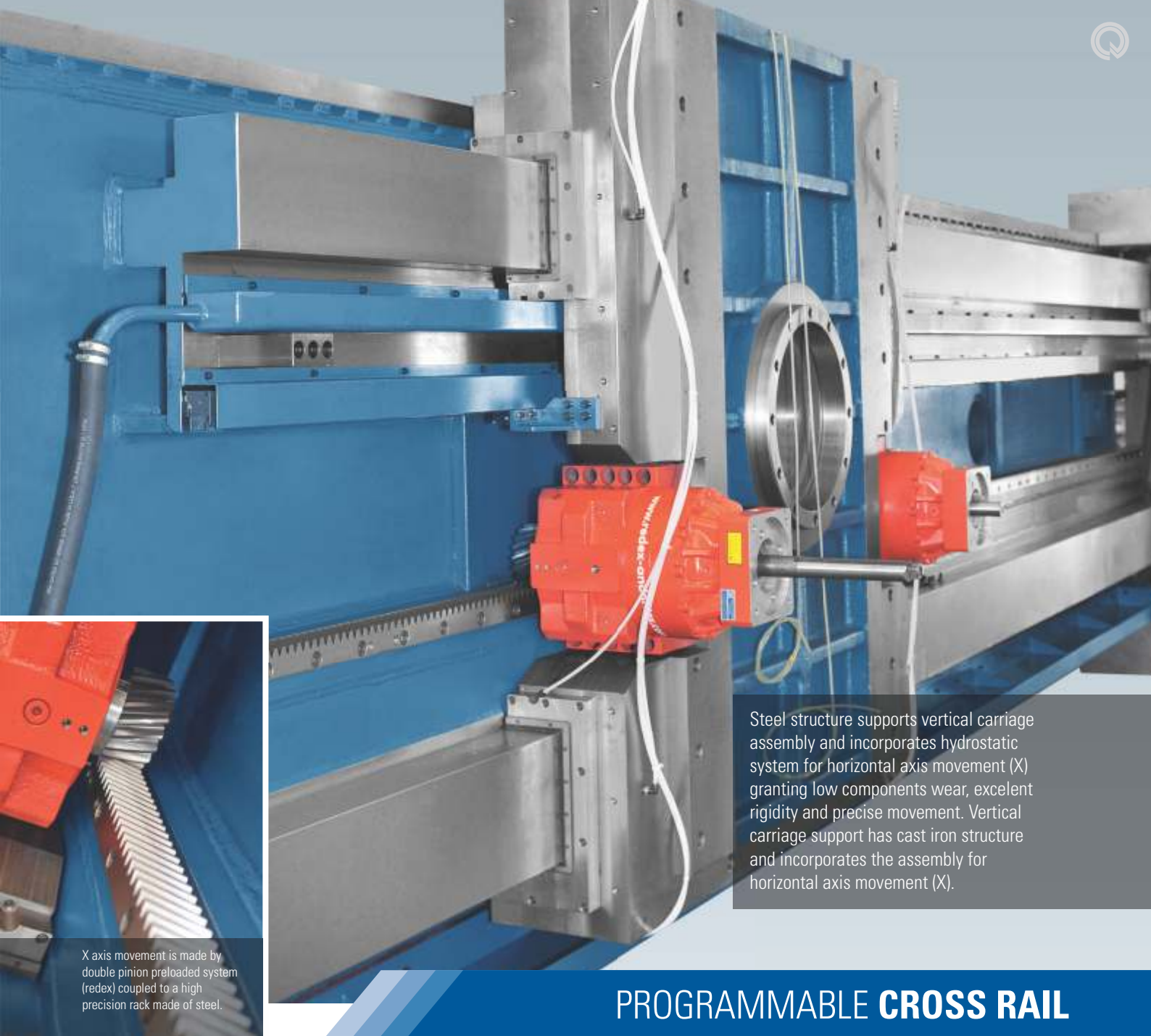

Steel structure supports vertical carriage assembly and incorporates hydrostatic system for horizontal axis movement (X) granting low components wear, excellent rigidity and precise movement. Vertical carriage support has cast iron structure and incorporates the assembly for horizontal axis movement (X).

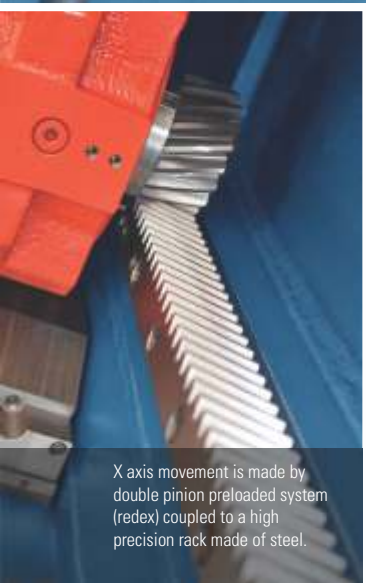

X axis movement is made by double pinion preloaded system (redex) coupled to a high precision rack made of steel.

PROGRAMMABLE CROSS RAIL

Vertical CARRIAGE

It has cast iron structure and incorporates the vertical axis assembly (Z) with hydrostatic system ensuring low components wear, excellent rigidity and precise movement.

RAM

Made of machined forged steel with section 350 x 350 mm (13.8" x 13.8"), 2,000 mm (79") travel, it has hydraulic system for tool locking & unlocking and it can incorporate driven tool system, 40 hp / 30 kW, 3,000 max. rpm, with interface for BT- 50 tools.





CNC

Technology, high performance and reliability

CNC Vertical Lathes from ROMI VT Series are equipped with CNC Siemens Sinumerik 840D sl which, offers the user very ease programming system.

CNC Siemens Sinumerik 840D sl offers 19" LCD color monitor, USB port and ethernet interface for factory network, bringing a great flexibility for loading programs and parameters.

Conversational programming programGUIDE

CNC Siemens Sinumerik 840D sl programGUIDE facilitates program creation thru the input of data in user-friendly screens and animated elements which helps in unequivocal data input. Programming is simplified thru cycles of drilling, boring, tapping and milling and free-shape profile cuts.



Technical specifications		VT 1400M	VT 2000M	VT 2500M	VT 3000M	VT 5000	VT 6000
Capacity							
Max. turning diameter	mm (in)	1,600 (63)	2,200 (87)	2,700 (106)	3,400 (134)	7,000 (276)	7,000 (276) / 8,000 (315) (*)
Max. swing diameter	mm (in)	1,600 (63)	2,200 (87)	2,800 (110)	3,400 (134)	7,000 (276)	7,000 (276) / 8,000 (315) (*)
Max. height allowed	mm (in)	1,650 (65)	1,650 (65)	2,250 (89)	2,250 (89)	4,000 (157)	4,000 (157)
Max. turning height (with RAM)	mm (in)	1,500 (59)	1,500 (59)	2,100 (83)	2,100 (83)	4,000 (157)	4,000 (157)
Feeds							
Rapid traverse (Z axis)	m/min (in/min)	20 (787)	20 (787)	20 (787)	20 (787)	10 (394)	10 (394)
Rapid traverse (X axis)	m/min (in/min)	20 (787)	20 (787)	20 (787)	20 (787)	10 (394)	10 (394)
Chuck							
Chuck diameter	mm (in)	1,400 (55)	2,000 (79)	2,500 (98)	3,000 (118)	5,000 (197)	6,000 (236)
Speed ranges	rpm	1 to 335	1 to 250	1 to 180	1 to 150	0 to 50	0 to 50
Range 1	rpm	1 to 100	1 to 100	1 to 65	1 to 65	0 to 25	0 to 25
Range 2	rpm	1 to 335	1 to 250	1 to 180	1 to 150	0 to 50	0 to 40
Max. weight allowed on chuck	kg (lbs)	10,000 (22,000)	15,000 (33,000)	25,000 (55,100)	25,000 (55,100)	90,000 (198,400)	90,000 (198,400)
C axis							
Max. torque	N.m (lbf.ft)	31.500 (23,200)	39.000 (28,765)	52.000 (38,350)	52.000 (38,350)	108.000 (19,650)	108.000 (79,650)
Speed range	rpm	0 to 2	0 to 2	0 to 2	0 to 2	0 to 2	0 to 2
Vertical RAM with driven tool							
Max. travel (RAM)	mm (in)	1,000 (39)	1,000 (39)	1,500 (59)	1,500 (59)	2,000 (79)	2,000 (79)
Max. travel cross rail	mm / in	900 (6 x 150) 35 (6 x 5.9)	900 (6 x 150) 35 (6 x 5.9)	1,386 (9 x 154) 55 (9 x 6.1)	1,386 (9 x 154) 55 (9 x 6.1)	2,976 (8 x 372) 117 (8 x 14.6)	2,976 (8 x 372) 117 (8 x 14.6)
Max. travel program (X axis)	mm (in)	1,145 (45)	1,445 (57)	1,695 (67)	1,945 (77)	3,910 (154)	4,410 (174)
Dimension RAM square	mm (in)	250 x 250 (9.8 x 9.8)	250 x 250 (9.8 x 9.8)	250 x 250 (9.8 x 9.8)	250 x 250 (9.8 x 9.8)	350 x 350 (13.8 x 13.8)	350 x 350 (13.8 x 13.8)
Spindle taper	ISO	50	50	50	50	50	50
Speed range	rpm	3 to 3,000	3 to 3,000	3 to 3,000	3 to 3,000	3 to 3,000	3 to 3,000
Max. torque	N.m (lbf.ft)	700 (516.3)	700 (516.3)	700 (516.3)	700 (516.3)	700 (516.3)	700 (516.3)
Driven tool motor	hp / kW	40 / 31	40 / 31	40 / 31	40 / 31	40 / 30	40 / 30
Max. number of tools in magazine	un	20	20	20	20	10	10
Installed power	hp / kW	2x42 / 2x31	2x42 / 2x31	2x42 / 2x31	2x42 / 2x31	2x72 / 2x54	2x72 / 2x54
Dimensions and weight (approx.)							
Height	m (in)	5,6 (220)	5,6 (220)	6,8 (268)	6,8 (268)	12,2 (480)	12,2 (480)
Floor space required (front x side)	m (in)	8,3 x 5,7 (327 x 224)	8,7 x 5,7 (342 x 224)	9,0 x 5,2 (354 x 205)	9,3 x 5,2 (366 x 205)	18,3 x 10,6 (720 x 417)	20 x 13 (787 x 512)
Net weight	kg (lbs)	39.000 (85980)	43.000 (94800)	57.000 (125,700)	60.000 (132,300)	207.000 (456,400)	237.000 (522,500)

(*) Optional under request

WORLDWIDE PRESENCE

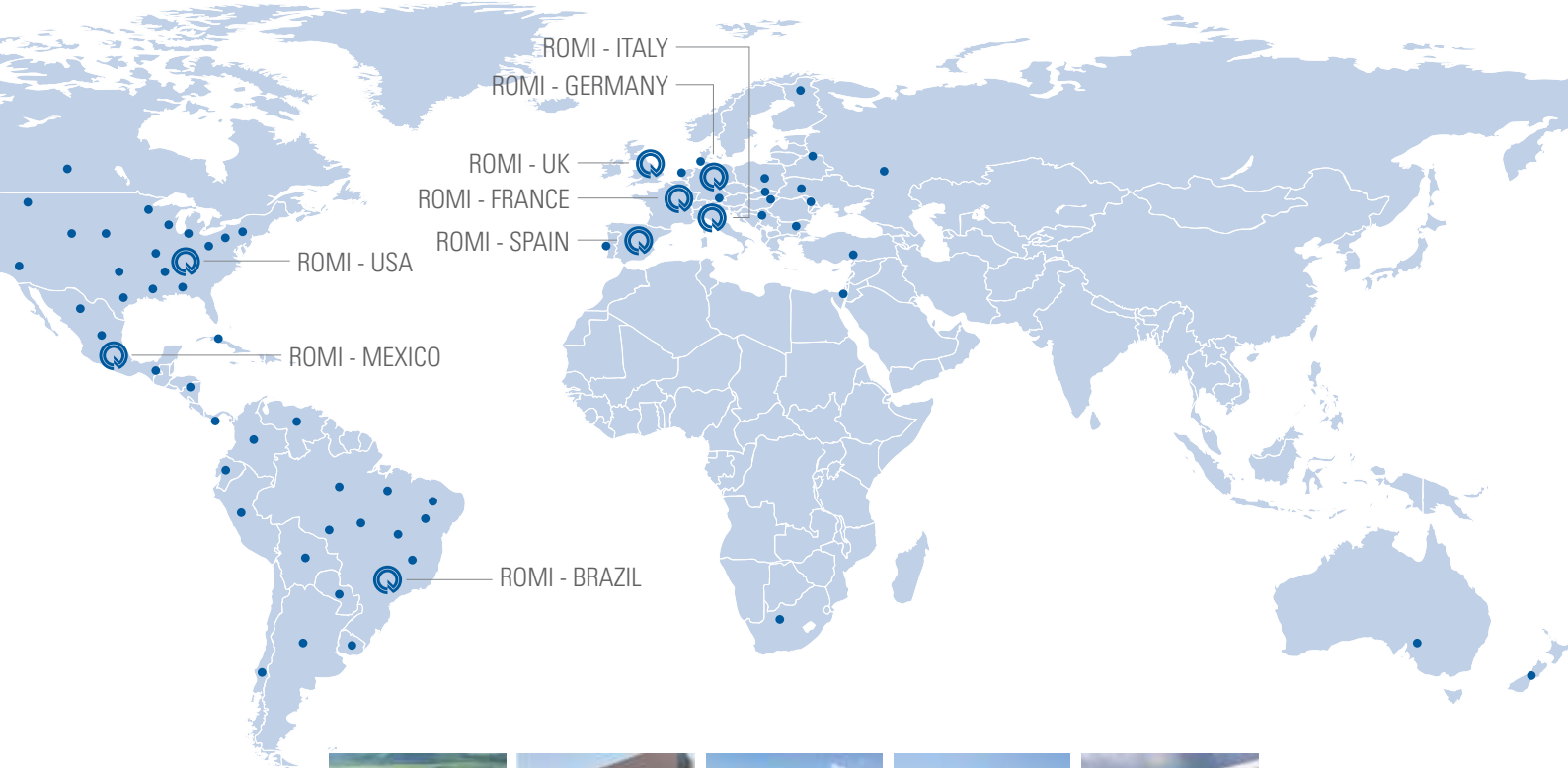

Brazil



United States



Germany



England



France



Spain



Italy



Mexico



Germany - B+W



ROMI

WWW.ROMI.COM

Romi SA

Rod. SP 304, Km 141,5
Santa Bárbara d'Oeste SP
13459 057 Brazil
+55 (19) 3455 9000

América Latina

+55 (19) 3455 9800
export-mf@romi.com

Burkhardt+Weber Fertigungssysteme GmbH

Burkhardt+Weber-Strasse 57
72760 Reutlingen, Germany
+49 7121 315-0
info@burkhardt-weber.de
www.burkhardt-weber.de

ROMI Machine Tools, Ltd

1845 Airport Exchange Blvd
Erlanger KY - 41018 USA
+1 (859) 647 7566
sales@romiusa.com
www.romiusa.com

ROMI Europa GmbH

Burkhardt+Weber-Strasse 57
72760 Reutlingen, Germany
+49 7121 315-604
sales@romi-europa.de
www.romi-europa.de

ROMI France SAS

Parc de Genève, 240
Rue Ferdinand Perrier 69800
ST Priest
+33 4 37 25 60 70
infos@romifrance.fr
www.romifrance.fr

ROMI Machines UK Limited

Leigh Road
Swift Valley Industrial Estate
Rugby CV21 1DS
+44 1788 544221
sales@romiuk.com
www.romiuk.com

ROMI Máquinas España

Calle Comadrán, 15
Pol. Ind. Can Salvatela
C.P. 08210 - Barberà del Vallès
+34 93 719 4926
info@romi.es
www.romi.es

ROMI en México

Condominio Parque Arista, Calle
Gral. Mariano Arista 54, bodega 19
Col. Argentina Poniente, Miguel Hidalgo
C.O. 11230, CDMX, México
+521 55 9154 5851
ventasmx@romi.com
www.romimexico.com

ROMI Italia Srl

Via Morigi, 33-29020
Gossolengo (PC) - Italia
+39 0523 778 956
commerciale@romiitalia.it
www.romiitalia.it



ISO 9001:2015
Certificate No. 31120



ISO 14001:2015
Certificate No. 70671

CE safety regulation compliance available only for the European Community or under request.
Check availability and technical characteristics of the products to your country.